

LATCHING HANDLES

**Luxury push button cabinet knobs, cabinet pulls and button knobs.
Our latching handles are spring loaded, securing the door without locking it.**

Used regularly in the marine industry but becoming increasingly popular in the residential sector, due to their space saving and ease of use, these are the perfect way to secure doors and cabinets with style and elegance. Handmade by a skilled team in our Devon factory and finished to the highest quality, a wide range of latching handles are available with matching hardware to complete any fitting look.

All our latching handles come in range of finish and design options. Custom options are also available. For more information contact our sales team.

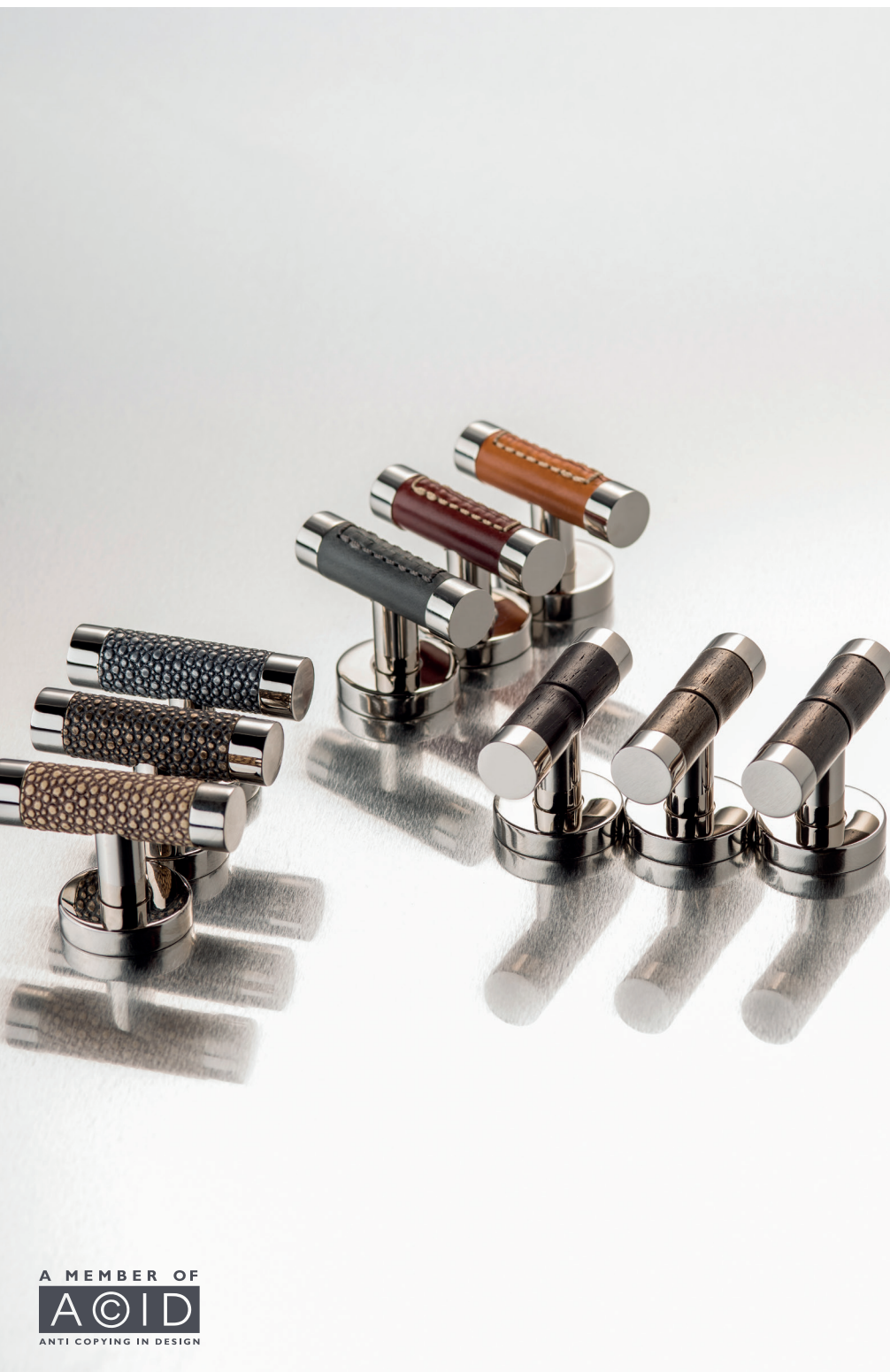

SOLID - S1686



SOLID HAMMERED - S1686



HAMMERED FINISHES

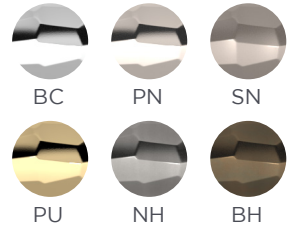

RECESS LEATHER

STITCH IN - C1481

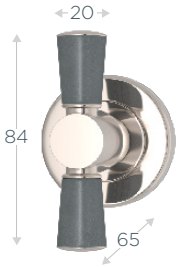

STITCH OUT - C1290



LEATHER GRIP FINISHES



AMALFINETM

TUBE - D1686

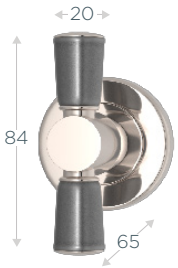

BAMBOO - D1291

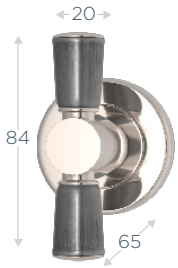

FACETED - D1811

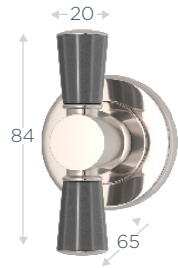

SHAGREEN - D2584



AMALFINE GRIP FINISHES

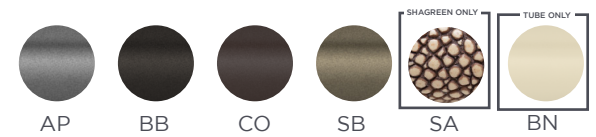

SOLID METAL FINISHES

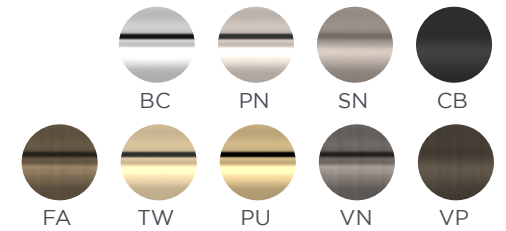

See website for full dimensions and specification details



SOLID - S2017

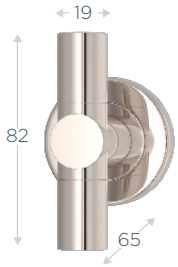

SOLID HAMMERED BARREL - HS2017

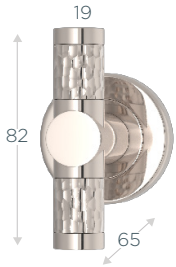

HAMMERED FINISHES

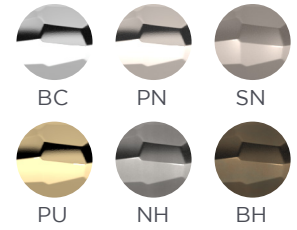

RECESS LEATHER

STITCH IN - R1913

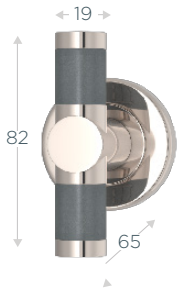

STITCH OUT - R1911

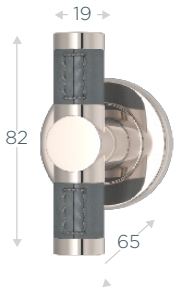

SOLID METAL FINISHES

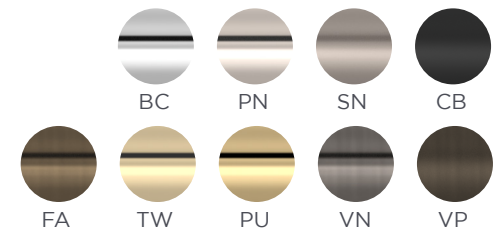

RECESS AMALFINE™

BARREL - P2017

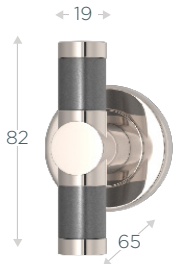

ROUGH CUT - P2359

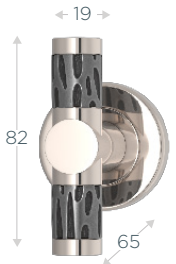

SHAGREEN - P1912

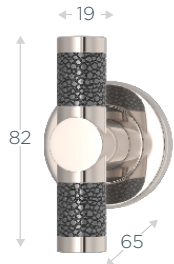

LEATHER GRIP FINISHES



AMALFINE GRIP FINISHES

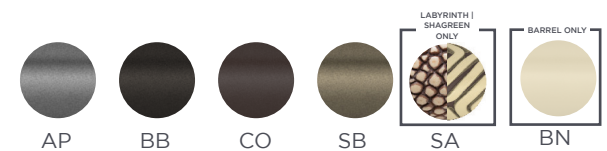

WIRE - P2361

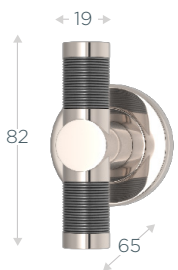

WOVEN - P2330

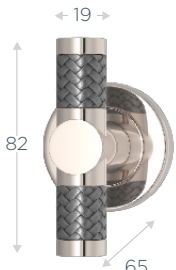

FACETED - P3408

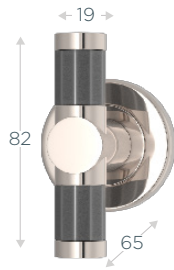

LABYRINTH - B8254

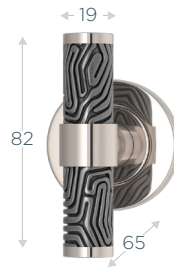

See website for full dimensions and specification details



AMALFINE™

Barrel - B2044

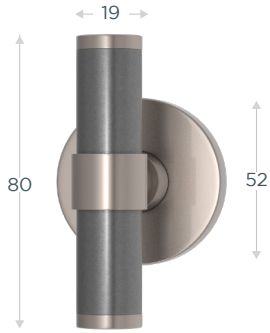

Projection: 64mm

Woven - B2010

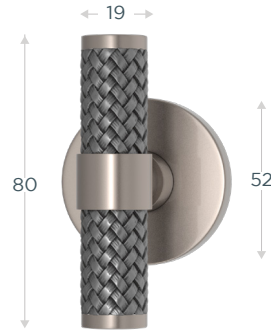

Projection: 64mm

Shagreen - B2000

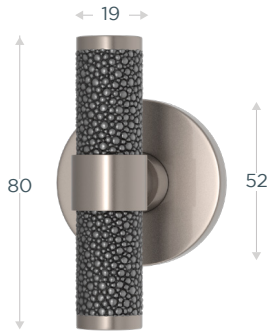

Projection: 64mm

Labyrinth - B8254

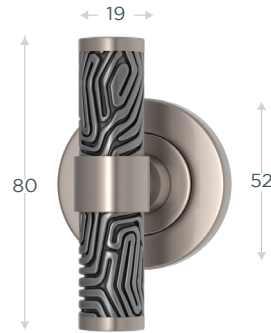

Projection: 64mm

Wire - B2025

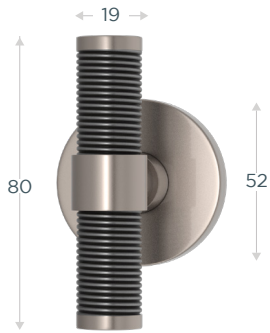

Projection: 64mm

NAME	CODE	ROSE (mm)	LENGTH (mm)	PROJECTION (mm)	WIDTH (mm)
BARREL	B2044	52	80	64	19
SHAGREEN	B2000	52	80	64	19
WIRE	B2025	52	80	64	19
WOVEN	B2010	52	80	64	19
LABYRINTH	B8254	52	80	64	19

AMALFINE™ FINISHES

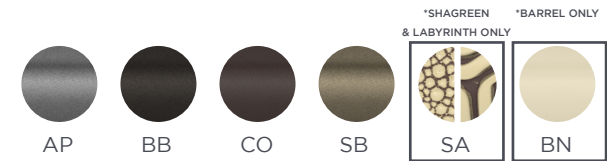

METAL FINISHES

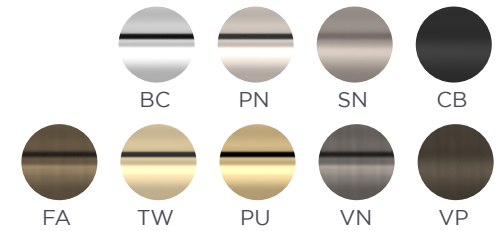

SOLID

Barrel - BS3322

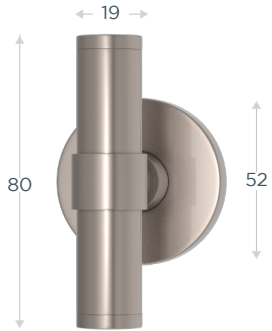

Projection: 64mm

Barrel - BH3322

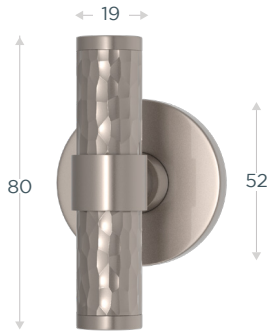

Projection: 64mm

LEATHER

Barrel Stitch In - BL5099

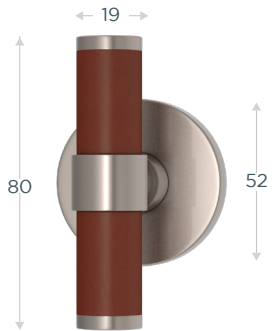

Projection: 64mm

NAME	CODE	ROSE (mm)	LENGTH (mm)	PROJECTION (mm)	WIDTH (mm)
BARREL STEPPED SOLID	BS3322	52	80	64	19
BARREL STEPPED SOLID HAMMERED	BH3322	52	80	64	19
BARREL STITCH IN STEPPED RECESS LEATHER	BL5099	52	80	64	19

SOLID FINISHES

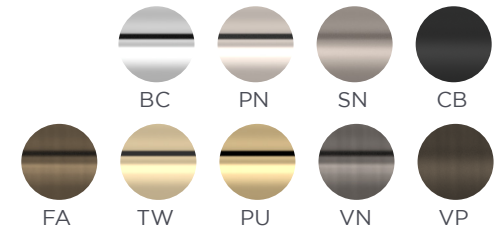

SOLID HAMMERED FINISHES

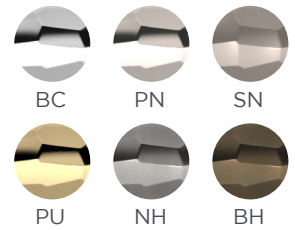

LEATHER FINISHES



SOLID

SOLID - S1003



RECESS LEATHER

BARREL (STITCH IN) - R1027

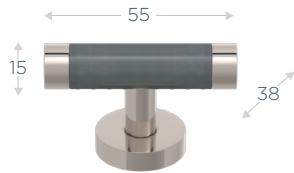

BARREL (STITCH OUT) - R1026

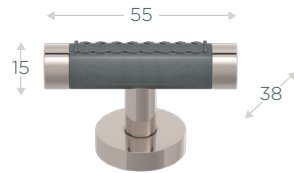

RECESS AMALFINE™

BAMBOO - P1012

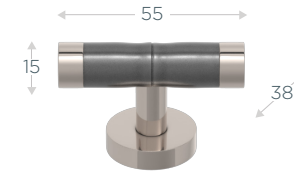

ROUGH CUT - P1013

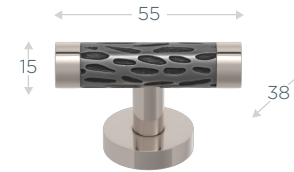

SHAGREEN - P3016

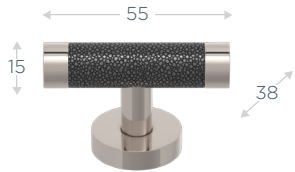

WIRE - P3036

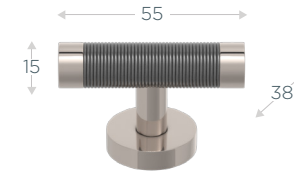

WOVEN - P3030

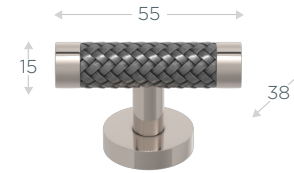

FACETED - P3022

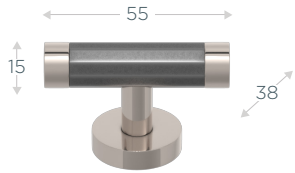

LABYRINTH - B9222

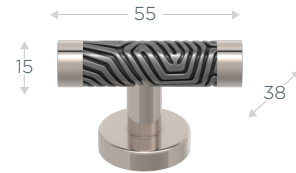

SOLID METAL FINISHES

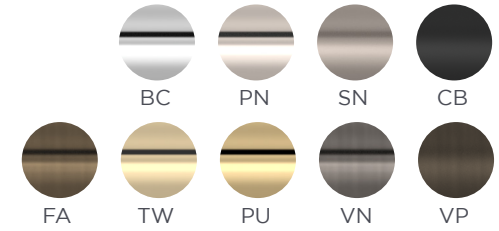

LEATHER GRIP FINISHES



AMALFINE GRIP FINISHES

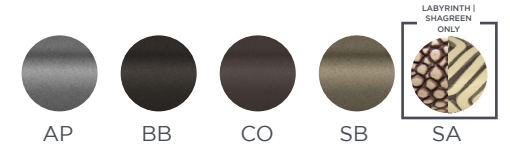

See website for full dimensions and specification details

ALL CABINET T BAR HANDLES ALSO AVAILABLE AS FIXED DEAD OPTION

Contact Turnstyle Sales Department for information



AMALFINE™

SHAGREEN BUTTON - P2993

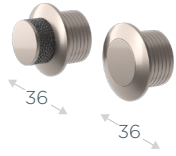

FACETED BUTTON - P3013

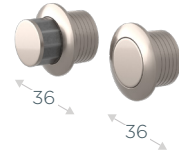

WIRE BUTTON - P3008

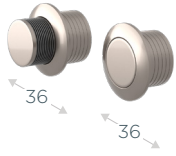

LABYRINTH BUTTON - B9009

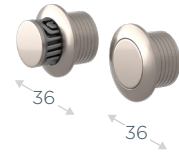

SOLID

DOMED BUTTON ON ROUND- S3044

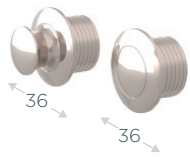

DOMED BUTTON ON SQUARE- S3045

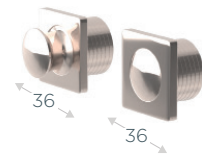

KNURLED BUTTON ON ROUND - S3046

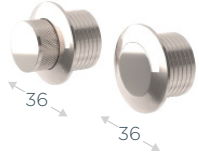

SQUARE BUTTON ON SQUARE - S3049

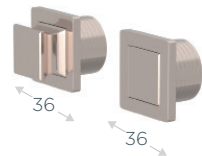

SQUARE BUTTON ON ROUND - S3048

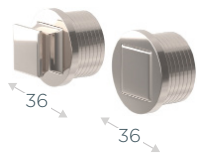

RECESS LEATHER - R2986

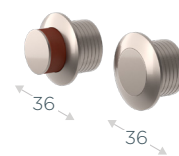

AMALFINE GRIP FINISHES

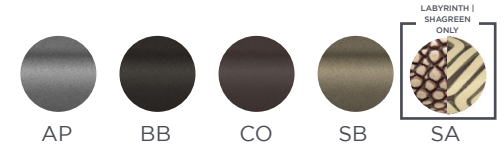

SOLID METAL FINISHES

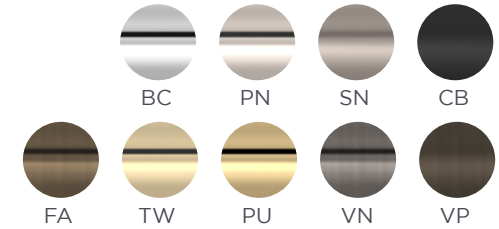

See website for full dimensions and specification details

ALL PUSH BUTTONS ON ROUND OR SQUARE:

Projection: 3mm (in closed position)

Contact Turnstyle Sales Department for required latch options



TURNSTYLE
DESIGNS

LEATHER GRIP FINISHES



SQUARE

RECESS LEATHER - H2009

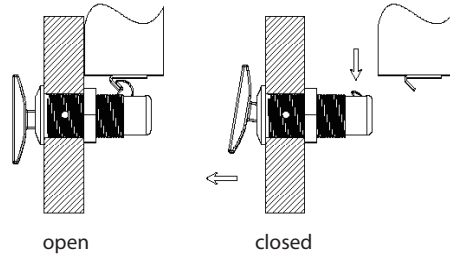

LEATHER GRIP FINISHES

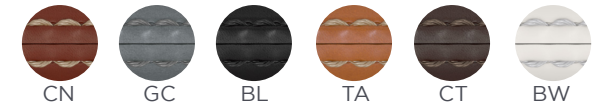

LEDGE

RECESS LEATHER - R1989

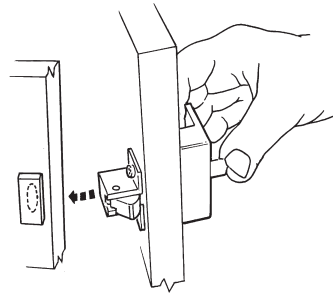

SOLID METAL FINISHES

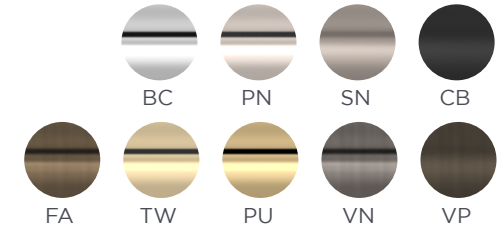

See website for full dimensions and specification details

SOLID - S1989



SOLID HAMMERED - HS1989



HAMMERED FINISHES

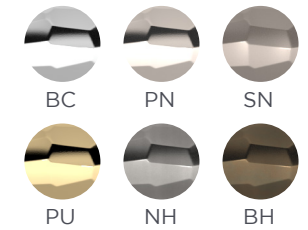

SQUARE LOOP (PLAIN) - UP1200

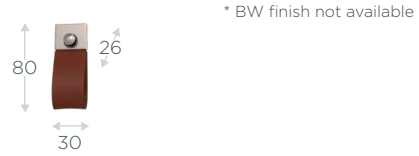

SQUARE LOOP (STITCHED) - U1200

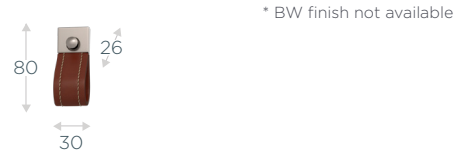

SQUARE STRAP (PLAIN) - UP1440

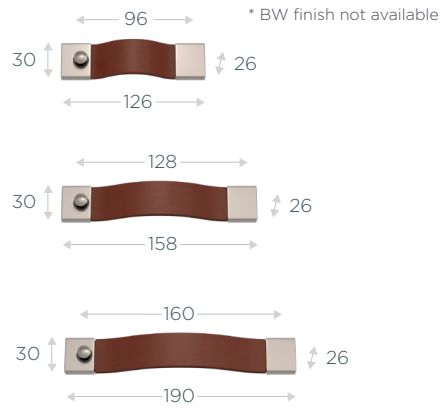

SQUARE STRAP (STITCHED) - U1440

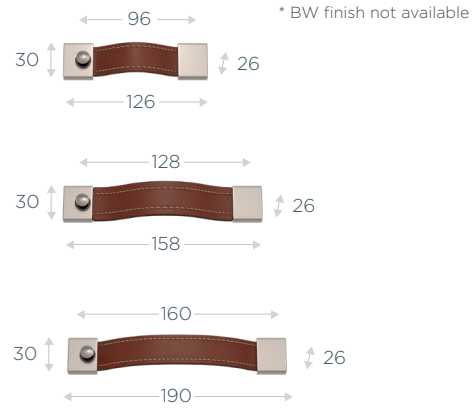

SQUARE D - R6000

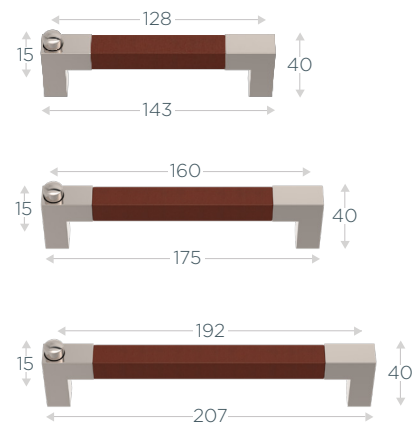

SQUARE D (STITCH OUT) - R7568

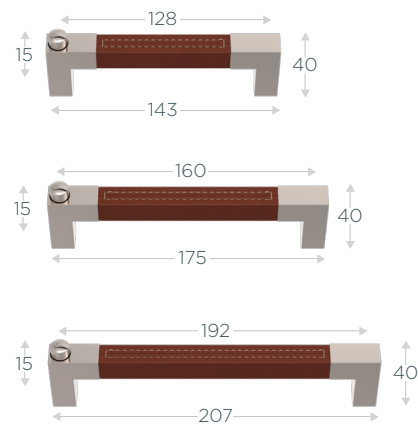

LEATHER GRIP FINISHES

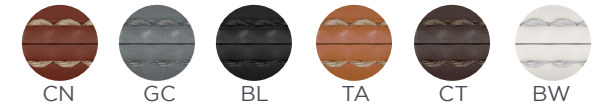

SOLID METAL FINISHES

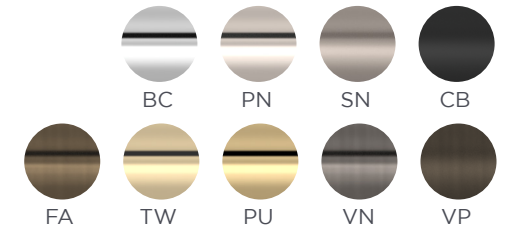

See website for full dimensions and specification details



RECESS LEATHER - R6500

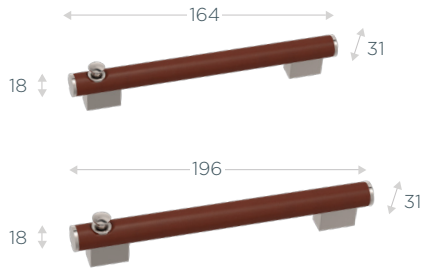

RECESS LEATHER (STITCH OUT) - R7570

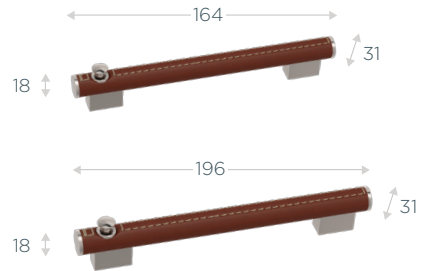

SOLID - S7002

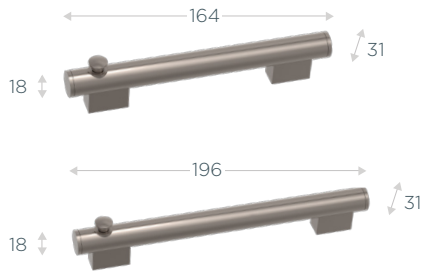

LEATHER GRIP FINISHES

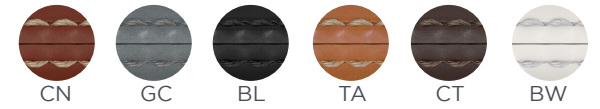

SOLID METAL FINISHES

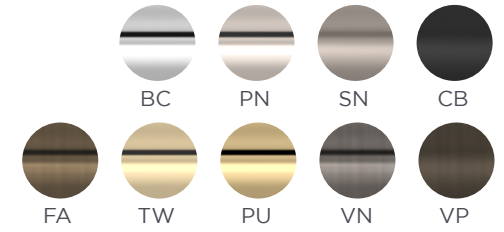

See website for full dimensions and specification details



TURNSTYLE
DESIGNS

RECESS LEATHER

RECTANGLE FLUSH PULL (TURN)- R1955



SOLID

RECTANGLE FLUSH PULL (COIN RELEASE)- R1955



RECTANGLE FLUSH PULL (COIN RELEASE)- R1955

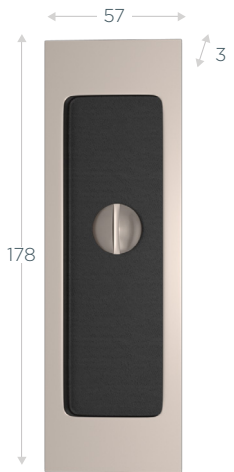

RECTANGLE FLUSH PULL (COIN RELEASE)- R1955



ROUND REVOLVING FLUSH PULL - C1954

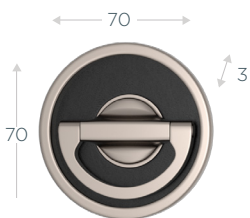

ROUND REVOLVING FLUSH PULL - C1954

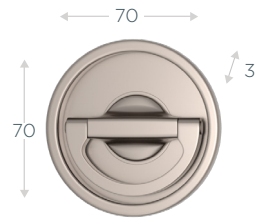

FAUX LEATHER GRIP FINISHES



LEATHER GRIP FINISHES

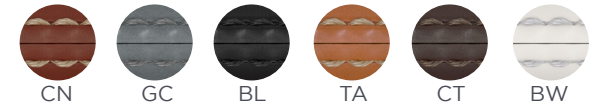

SOLID METAL FINISHES

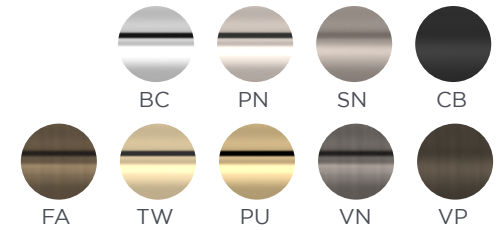

See website for full dimensions and specification details

